



SHANGHAI EVEN MEDICAL INSTRUMENTS CO.,LTD

PRODUCT CATALOGUE 2026

GROW YOUR COMPANY WITH US



ADDRESS

Room 201, #2 Lingguang Building, 2511
West Huancheng Rd, Fengxian District,
201400, Shanghai, China.



CONTACT

info@shevenmed.com
<https://shevenmed.com>



ABOUT COMPANY



Shanghai Even Medical Instruments Co., Ltd was located in the most flourishing commercial and financial center of China-Shanghai city. We are a professional comprehensive enterprise with the status of legal entity in importing and exporting the Surgical Dressing and Surgical Equipment and all the related medical items including high-tech equipment researching and development as well.

Our company mainly handles in: Surgical Dressing, Medical Disposables, Laboratory Disposables. Our products have been sold to many countries and regions in the world such as Europe, America, Southeast Asia, Oceania, Middle East, Africa etc. Meanwhile we kept close relationships with many professional manufacturer and units in over 30 provinces to ensure a steady supply of goods.

Surgical Suture



Non-absorbable Surgical Suture

Item No	Item	Color	Diameter(USP)	Sterile	Packing
E20001	Silk (Braided)	Black or ivory	6/0-2	Gamma radiation	12pcs/box, 50boxes/carton, 33x28x27cm, 4kg/3.5kg
E20002	Polyester (Braided)	Green or blue	6/0-2	Gamma radiation	
E20003	Nylon (Monofilament)	Black or blue	6/0-2	Gamma radiation	
E20004	Polypropylene (Monofilament)	Blue	6/0-2	Gamma radiation	

Surgical Suture



Absorbable Surgical Suture

Item No	Item	Color	Diameter(USP)	Sterile	Packing
E20005	Chromic Catgut	Green or tan	6/0-2	Gamma radiation	12pcs/box, 50boxes/ctn, 33x28x27cm, 4kg/3.5kg
E20006	Plain Catgut	Straw	6/0-2	Gamma radiation	
E20007	Polyglycolic Acid	Violet or undyed	6/0-2	Ethylene oxide	
E20008	Polyglactin 910	Violet or undyed	6/0-2	Ethylene oxide	
E20009	Polydioxanone	Violet or undyed	6/0-2	Ethylene oxide	
E20010	Poliglecaprone 25	Violet or undyed	6/0-2	Ethylene oxide	

Surgical Blade



E20011C



E20011S



E20012C



E20012S3

E20012S4

Item No	Item	Description	Sterile	Packing
E20011C	Surgical blade	Carbon steel 6#-36# Gamma Radiation 25kGy	Gamma radiation	100pcs/box, 50boxes/ctn 36x20x17cm, 8.5kg/8kg
E20011S	Surgical blade	Stainless steel 6#-36# Gamma Radiation 25kGy	Gamma radiation	100pcs/box, 50boxes/ctn 36x20x17cm, 8.5kg/8kg
E20012C	Surgical Scalpel blade with Plastic Handle	Carbon steel 6#-36# Gamma Radiation 25kGy	Gamma radiation	10pcs/box, 50boxes/ctn 40x32x22cm, 6.5kg/6kg
E20012S	Surgical Scalpel blade with Plastic Handle	Stainless steel 6#-36# Gamma Radiation 25kGy	Gamma radiation	10pcs/box, 50boxes/ctn 40x32x22cm, 6.5kg/6kg
E20012S3	Stainless Scalpel handle	#3	Gamma radiation	500pcs/ctn 26*16*20cm
E20012S4	Stainless Scalpel handle	#4	Gamma radiation	500pcs/ctn 26*16*20cm

Disinfecting Wipe



E10016

Item No	Description
E10016	Alcohol Swabs Material: Non-woven Content: 70% Isopropyl Alcohol Size: 3*6.5cm, 4*6cm, 5*5cm, 7.5*7.5cm, 10*10cm or Customized Package: 1pcs/Paper aluminum bag, 100pcs or 200pcs/box Carton Size :42.5*28.5*28.5cm Weight: 11/10kgs



E10017

Item No	Description
E10017	Alcohol Swabs Material: Non-woven Content: 2% Chlorhexidine and 70% Isopropyl Alcohol Size: 3*6.5cm, 4*6cm, 5*5cm, 7.5*7.5cm, 10*10cm or Customized Package: 1pcs/Paper aluminum bag, 100pcs or 200pcs/box Carton Size :42.5*28.5*28.5cm Weight: 11/10kgs

Injection & Infusion



E20013

Item No	Item	Description	Packing
E20013	Syringe	Luer slip 1ml-60ml with needle or without needle 2-part or 3-part Sterile By EO gas	Individual package: Blister/PE packing

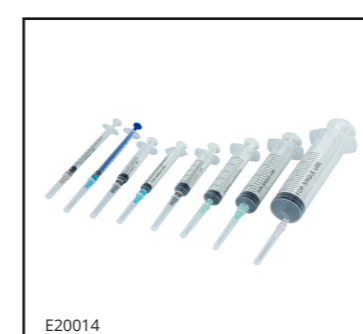

E20014

Item No	Item	Description	Packing
E20014	Syringe	Luer lock 1ml-60ml with needle or without needle 2-part or 3-part Sterile By EO gas	Individual package: Blister/PE packing



E20015

Item No	Item	Description	Packing
E20015	insulin syringe	0.5ml, 1ml Fixed or without fixed needle Needle Gauge 27G-30G	Individual package: Blister/PE packing

Injection & Infusion

Item No	Item	Description	Packing
E20017	I.V.Cannula with Butterfly Type	Gauge 14G-26G	50pcs/box, 20boxes/ctn
E20018	I.V.Cannula with Injection Port Type	Gauge 14G-26G	50pcs/box, 20boxes/ctn
E20019	I.V.Cannula with Pen-like Type	Gauge 14G-26G	50pcs/box, 20boxes/ctn
E20020	Scalp Vein Set with luer slip	Tube Length:35cm or customized Needle Gauge:20-23G	1pcs/inner bag 100pcs/bag 50bag/ctn 60*42*42cm
E20021	Scalp Vein Set with luer lock	Tube Length:35cm or customized Needle Gauge:20-23G	1pcs/inner bag 100pcs/bag 50bag/ctn 60*42*42cm

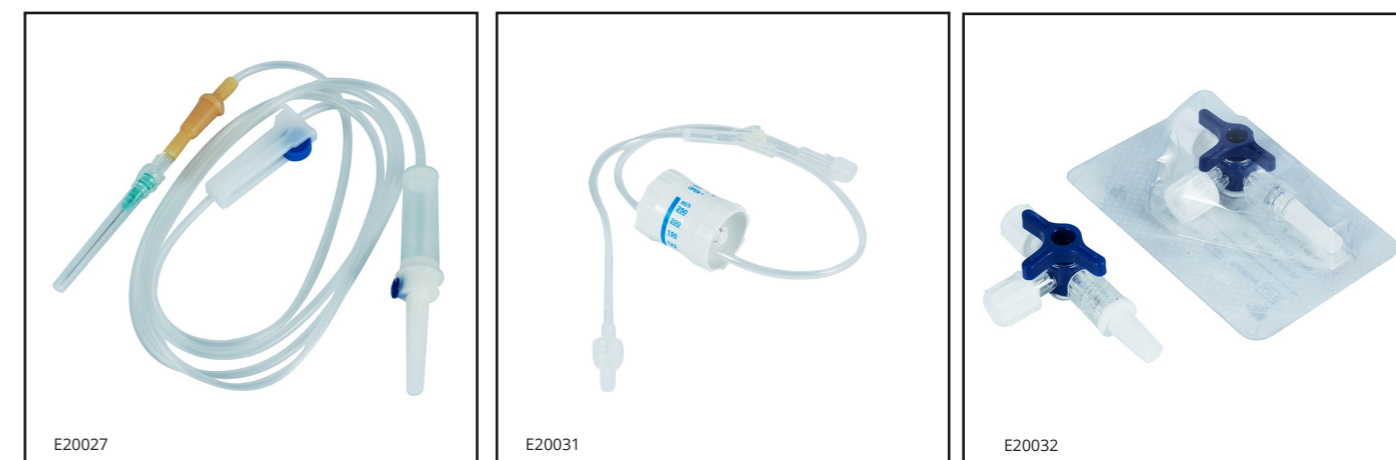

Infusion Set

IV Flow Regulator

Threeway Stopcock

Spinal Needle



Item No	Type	Description	Packing
E20022	Quincke Tip	PP + Stainless Steel Length 90-150mm Gauge 18-27G	50pcs/box, 20 boxes/ctn 46*42*36cm 8/7kgs
E20023	Pencil Point	PP + Stainless Steel Length 90-150mm Gauge 18-27G with or without introducer	

Epidural Needle

Item No	Type	Description	Packing
E20024	Epidural Needle	PP + Stainless Steel Length 90-150mm Gauge 18G	50pcs/box, 20 boxes/ctn 46*42*36cm 8/7kgs

Surgical Scrub Brush



Item No	Type	Description	Packing
E20037	Dry Surgical Scrub Brush	Sponge Brush 8x5x2.1cm	300pcs/ctn 58*37.5*40cm 4.75/3.75kgs
E20038	Surgical Hand Brush with Iodine	Sponge Brush 8x5x 2.1cm With Iodine 7.5%/10% 20ml	300pcs/ctn 58*37.5*40cm 14/13kgs
E20039	Surgical Hand Brush with Chlorhexidine	Sponge Brush 8x5x 2.1cm With chlorhexidine gluconate solution 4% 20ml	300pcs/ctn 58*37.5*40cm 14/13kgs

Endotracheal Tube



Endotracheal tube
ORAL/NASAL with Cuff

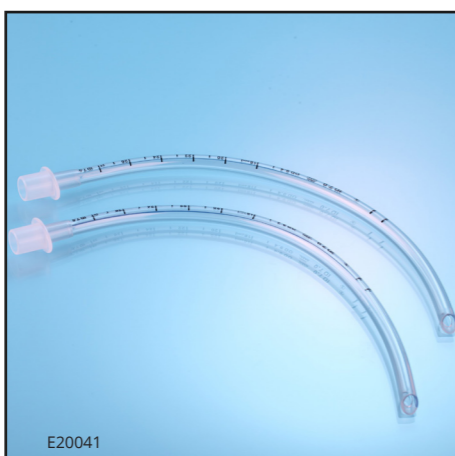

Endotracheal tube
ORAL/NASAL without Cuff



Reinforced Endotracheal Tube

Foley Catheter

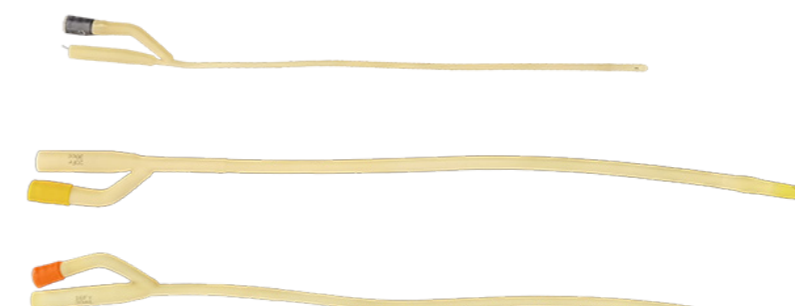
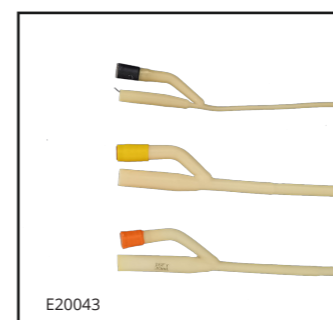

Item No	Item	Size	Model	Length	Packing
E20043	Latex Foley Catheter	FR6-Fr26	2-way pediatric	260-400mm	Individual package: Blister/PE packing 10pcs/box,50boxes/ctn
E20044	Silicone Foley Catheter		2-way Standard 2-way female 3-way standard		

Model	Size(Fr/Ch)	Balloon(CC)	Color	Length(mm)
2-way pediatric	6	3	Light red	270
	8	5	Black	270
	10	5	Grey	270
2-way Standard	12	15	White	400
	14	15	Green	400
	16	15	Orange	400
	18	30	Red	400
	20	30	Yellow	400
	22	30	Violet	400
	24	30	Blue	400
	26	30	Pink	400
2-way female	12	15	White	260
	14	15	Green	260
	16	15	Orange	260
	18	30	Red	260
	20	30	Yellow	260
	22	30	Violet	260
3-way standard	16	30	Orange	400
	18	30	Red	400
	20	30	Yellow	400
	22	30	Violet	400
	24	30	Blue	400
	26	30	Pink	400

Urine Bag

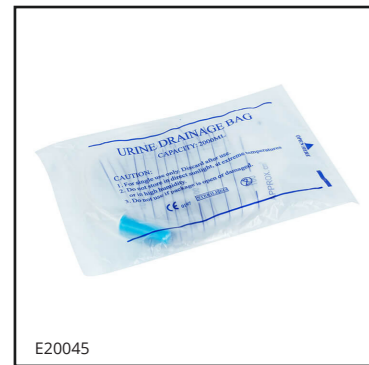

Item No	Model	Description	Packing
E20045	without Outlet Valve	Medical grade PVC Volume:2000ml	Individual package: Blister/PE packing



Item No	Model	Description	Packing
E20046	with Screw Valve	Medical grade PVC Volume:2000ml	Individual package: Blister/PE packing



Item No	Model	Description	Packing
E20047	with Push Pull Valve	Medical grade PVC Volume:2000ml	Individual package: Blister/PE packing



Item No	Model	Description	Packing
E20048	with T Valve (Cross Valve)	Medical grade PVC Volume:2000ml	Individual package:Blis- ter/PE packing

Vaginal Speculum



Item No	Model	Description	Packing
E20049	Side Screw	Medical PS Plastic Small/Medium/Large	1pcs/bag 100bags/carton



Item No	Model	Description	Packing
E20050	Middle Screw	Medical PS Plastic Small/Medium/Large	1pcs/bag 100bags/carton



Item No	Model	Description	Packing
E20051	French Type	Medical PS Plastic Small/Medium/Large Push-pull	1pcs/bag 100bags/carton



Item No	Model	Description	Packing
E20052	American Type	Medical PS Plastic Small/Medium/Large Fastener	1pcs/bag 100bags/carton

HCG Pregnancy Test

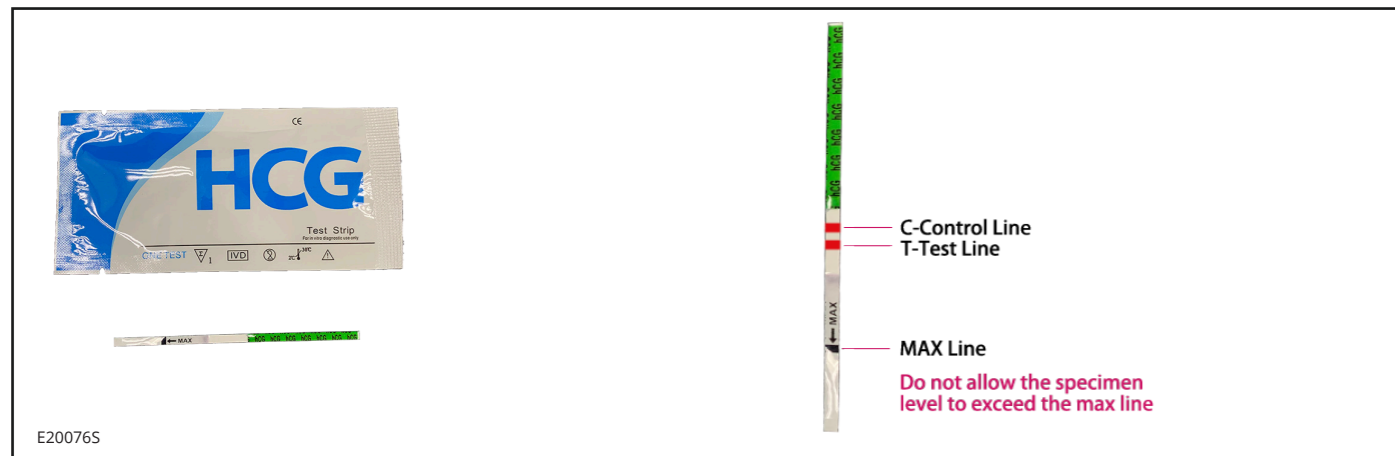

E20076S

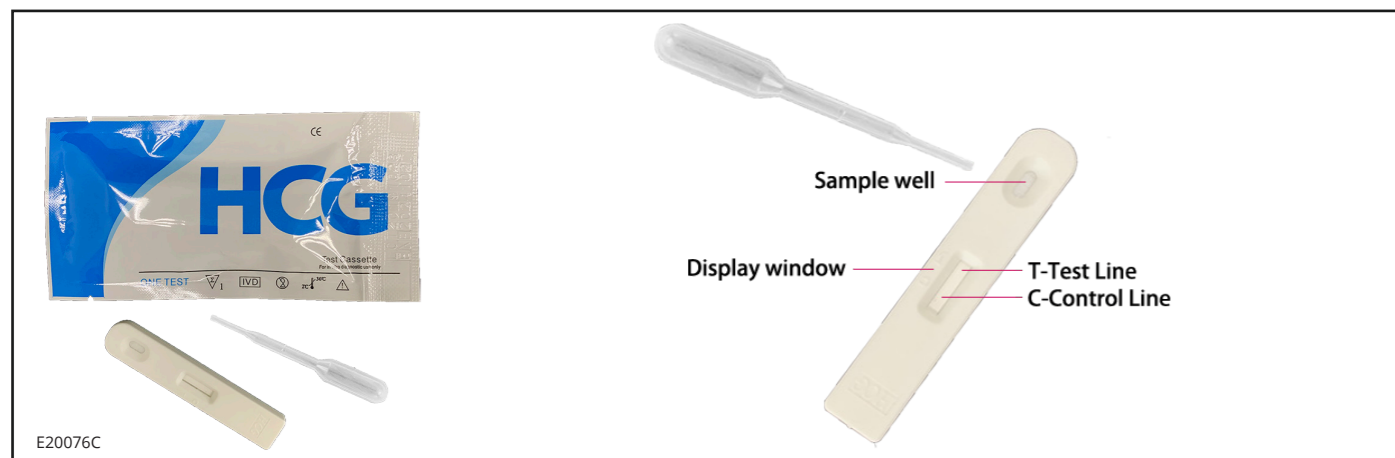

E20076C

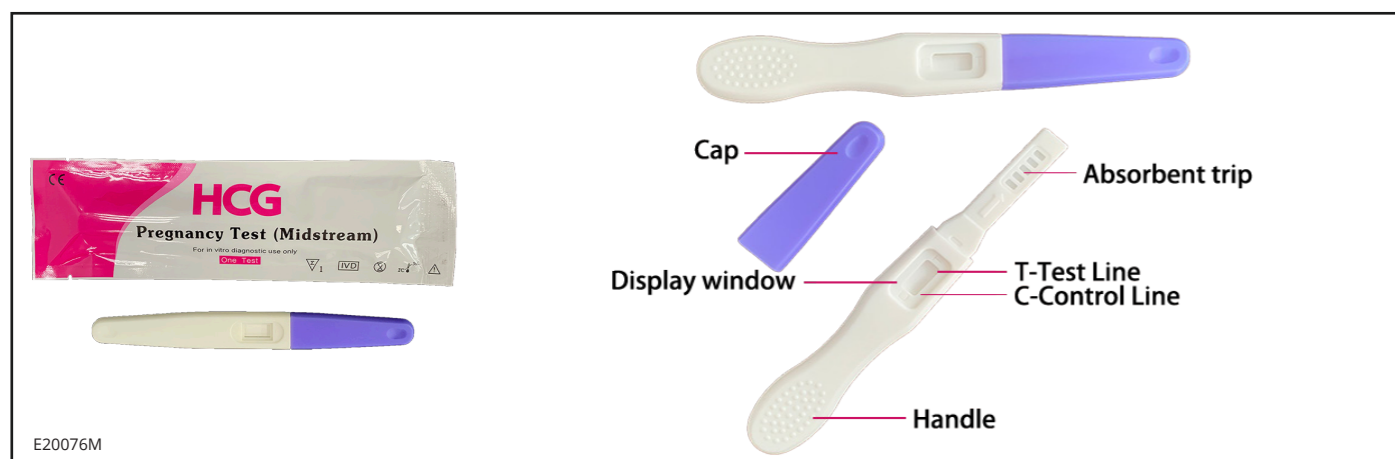

E20076M

Item No	Type	Description	Packing
E20076S	HCG Pregnancy Test Strip	2.5mm, 3.0mm, 4.0mm, 5.0mm	5000pcs/ctn 75*29*56cm
E20076C	HCG Pregnancy Test Cassette	3.0mm, 4.0mm	2500pcs/ctn 63*50*40mm
E20076M	HCG Pregnancy Test Midstream	3.0mm, 5.5mm, 6.0mm	1000pcs/ctn 63*46*34cm

Hemodialysis Products



E20053

Central Venous Catheter Kit

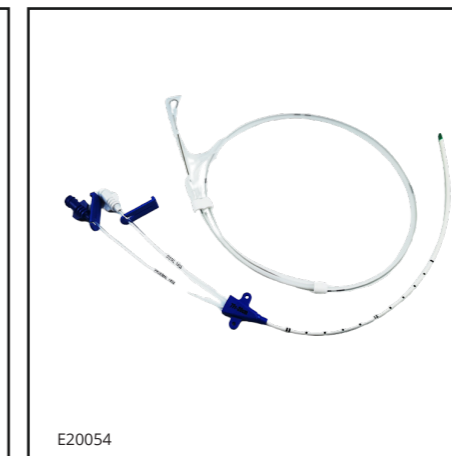

E20054

Central Venous Catheter

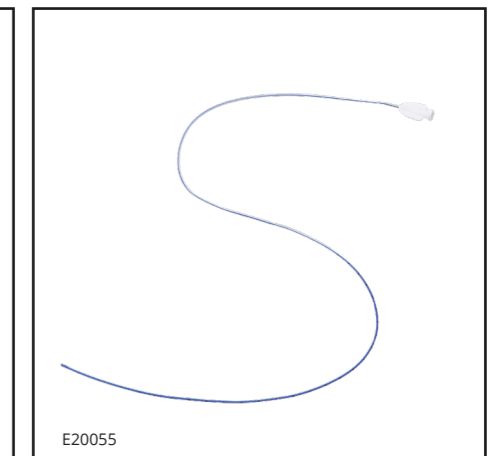

E20055

PICC--Peripherally inserted central catheter



E20056

Hemodialysis Catheter Kit

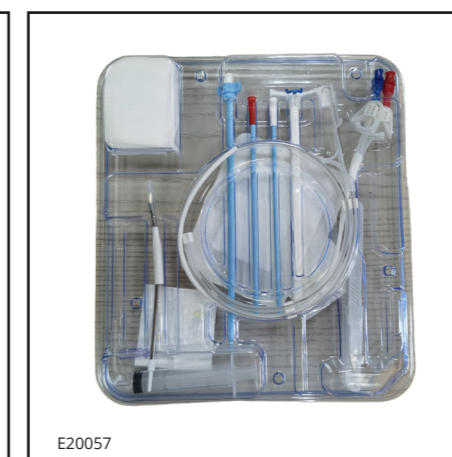

E20057

Long Term Hemodialysis Catheter Kit

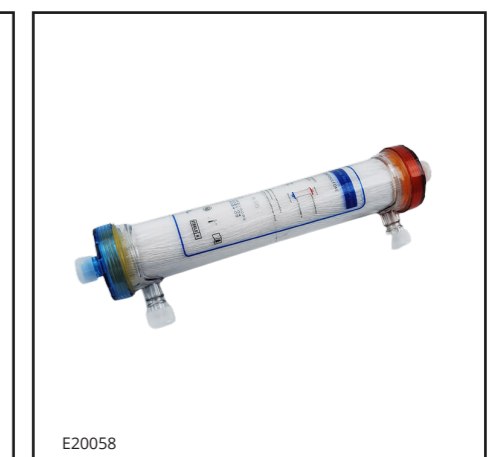

E20058

Hemodialyzer



E20059

A-V Blood line



E20060

AV Fistula Needle

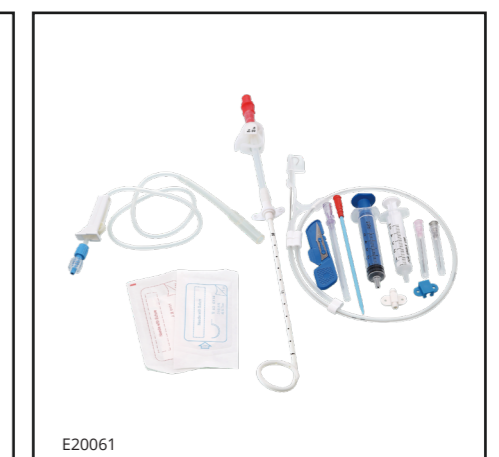

E20061

Drainage Catheter Kit

Other Consumables



E20062

Feeding Tube



E20063

Suction Catheter

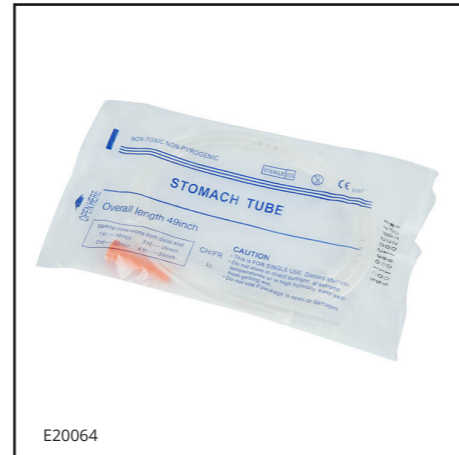

E20064

Stomach Tube



E20065

Nelaton Catheter



E20066

Male External Catheter



E20067

Medicine Envelope

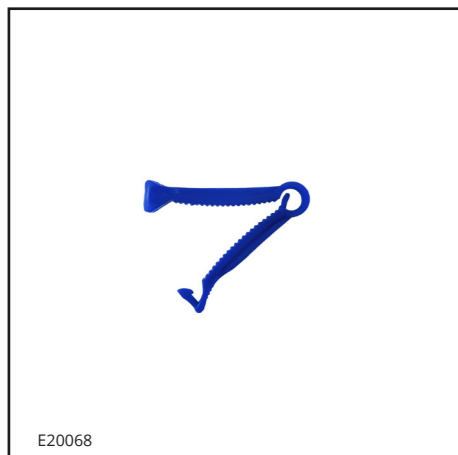

E20068

Umbilical Cord Clamp

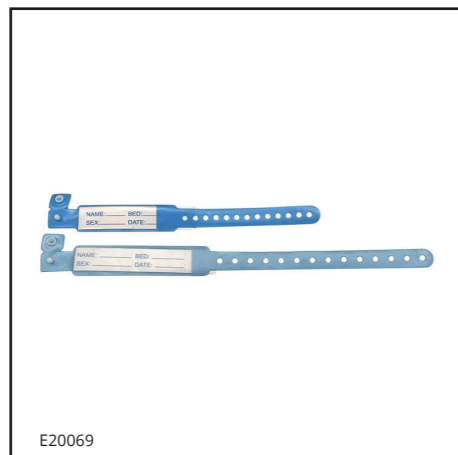

E20069

Identification Bracelet with card insert



E20070

Identification Bracelet write on



E20071

Simple Oxygen Mask

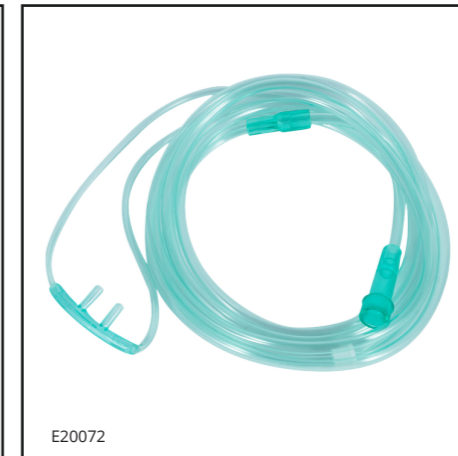

E20072

Nasal Oxygen Cannula



E20073

Nebulizer Mask



E20074

Anesthesia Mask



E20075

Medical Ultrasound Gel



E20078

Emergency Blanket



E20077B

Bamboo Tongue Depressor



E20077W

Wooden Tongue Depressor

Blood Collection Tube



Item No	Item	Type	Additive	Color	Application	Tube Spe.
E30001	Serum Tube	Plain Tube	None		Blood collection and storage for biochemistry, immunology, and serology tests in medical inspection	13*75/100 16*100
E30002		Pro-Coagulation Tube	Clot activator			
E30003		Gel+Clot Activator Tube	Gel+Clot Activator			
E30004	Plasma Tube	Heparin sodium	Heparin sodium Heparin lithium		Anticoagulation of blood specimen for the tests of clinic biochemistry and emergency biochemistry	13*75/100 16*100
E30005		PT tube	sodium citrate 1:9		PT, APTT, TT, FIB etc	13*75/100
E30006		Fluoride Tube	Glucose (sodium fluoride/potassium oxalate)		Anticoagulation of blood specimen for the tests of glucose tolerance, erythrocyte electrophoresis, etc	13*75/100
E30007		EDTA Tube	EDTA K2/K3		Normal clinical blood test	13*75/100 16*100
E30008	General Tube	ESR Tube	sodium citrate 1:4		Tests of erythrocyte sedimentation rate	13*75
E30009		Hydrophobia ESR Tube	Slender ESR tube (sodium citrate 1:4)			8*120

Blood Collection Needle



Butfly Blood Collection Needle



Blood Collection Needle with Pen Type

Blood Lancet

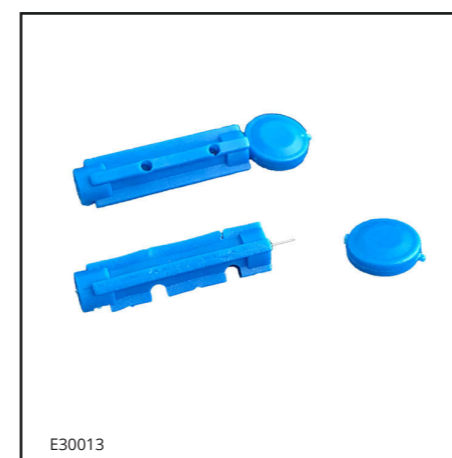

E30013

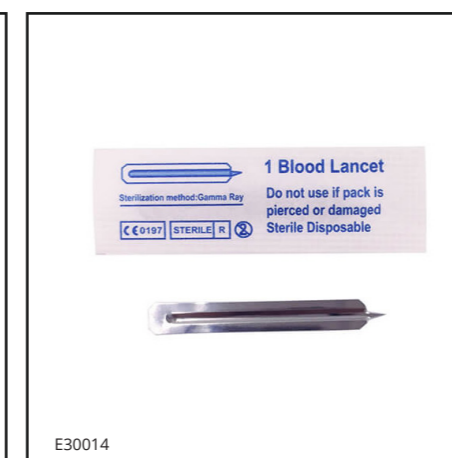

E30014

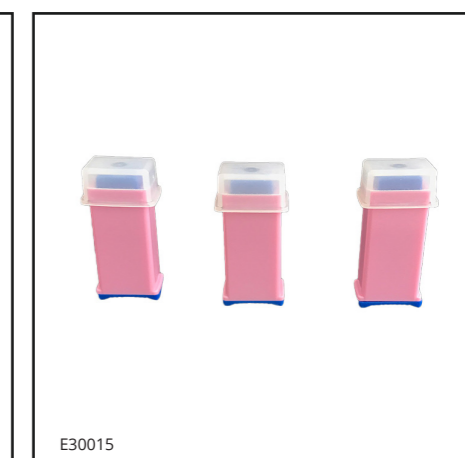

E30015



E30016

Item No	Type	Description
E30013	Twist Blood Lancet	28G/30G 6.3*32mm
E30014	Stainless Steel Lancet	Size: 40mm*5.5mm Exposed Length: 2.6mm - 3.8mm
E30015	Safety Blood Lancet	18G/21G/22G/23G/26G/28G/30G Depth: 1.8mm/2.4mm
E30016	Contact-activated Safety Blood Lancet Pen Type	21G/23G/26G/28G/30G Depth: 1.8mm/2.2mm/2.8mm

Specimen Collection Container



Sputum Cup

Urine Cup

Stool Cup

Item No	Type	Material	Cap Structure	Description	Packing
E30017	Sputum Container	PP/PS	Screw	30ml	40pcs/bag,25bags/ctn
E30018	Urine Container			30ml/40ml/60ml/100ml/120ml	16pcs/bag,50bags/ctn
E30019	Stool Container		Screw	30ml//60ml	40pcs/bag,25bags/ctn

Centrifuge Tube

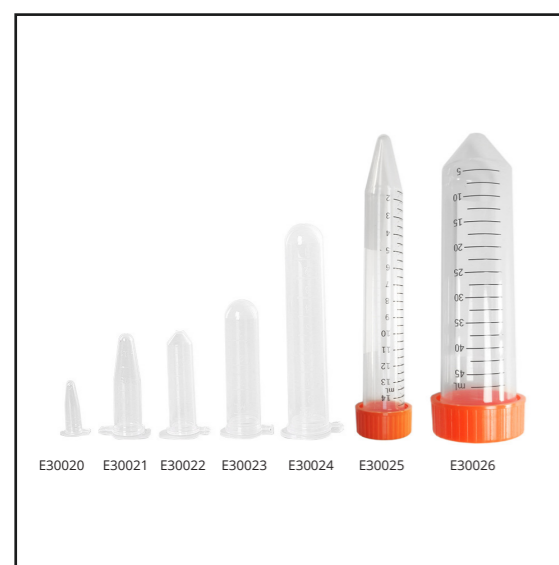

Item No	Type	Description
E30020	(RNase & DNase Free, Sterilized by Radiation)	0.5ml,PP
E30021		1.5ml,PP
E30022		2ml,PP
E30023		5ml,PP
E30024		10ml,PP
E30025		15ml,PP
E30026		50ml,PP

Wound Skin Closures



E40011

Item No	Specification	Description	Pcs/box	Boxes/carton
E40011w1203	12mm*100mm (3 Strips)	Wound of 50-100mm long	50pcs/box	40boxes/carton
E40011w0605	6mm*100mm (5 Strips)	Wound of 50-100mm long	50pcs/box	40boxes/carton
E40011w0603	6mm*75mm (3 Strips)	Wound of 50mm long	50pcs/box	40boxes/carton
E40011w0606	6mm*38mm (6 Strips)	Wound of 50mm long	50pcs/box	40boxes/carton
E40011w0305	3mm*75mm (5 Strips)	Wound of 50mm long	50pcs/box	40boxes/carton

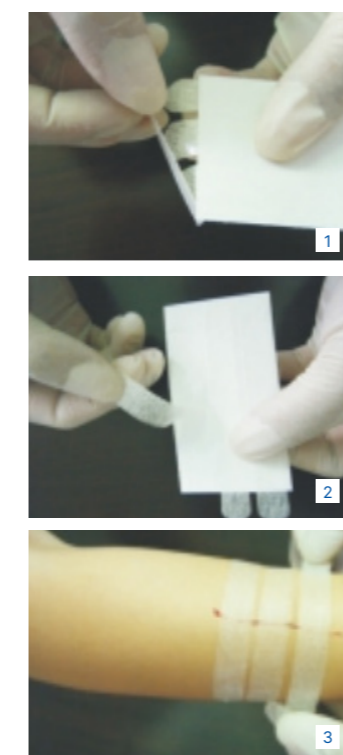
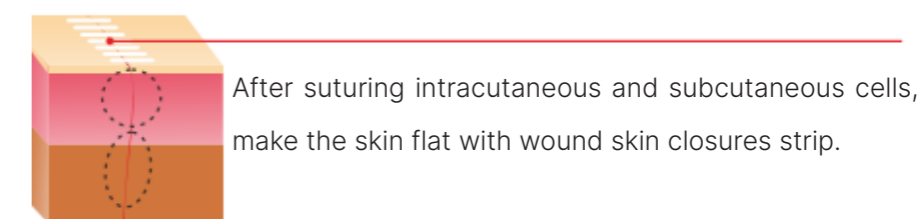
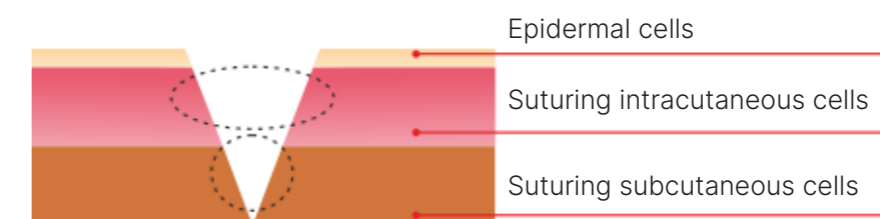

Illustration for how to use wound skin closure strip



Alginate Impression Material



Item No	Type	Application	Packing
E50001	Universal	General porcelain and jaw impression	500g or customized 24bags/ctn(454g/500g) Weight:13/12.5kgs 43*33*22cm
E50002	High Precision	Porcelain tooth impression	
E50003	Super High Precision	high precision local injection impression	

Composition/Information on Ingredient

Chemical name	CASNo.
Diatomite	61790-53-2
Calcium sulfate	7778-18-9
Sodium alginate	9005-38-3
Zinc oxide	1314-13-2
Disodium hexa fluoro titanate	17116-13-1
Trisodium orthophosphate	7601-54-9

Note: CASNo.is Chemical Abstract Service Registry Number.



Other Dental Consumables



Dental Bib



Dental Cotton Roll



Dental Saliva Ejector



Micro Applicator

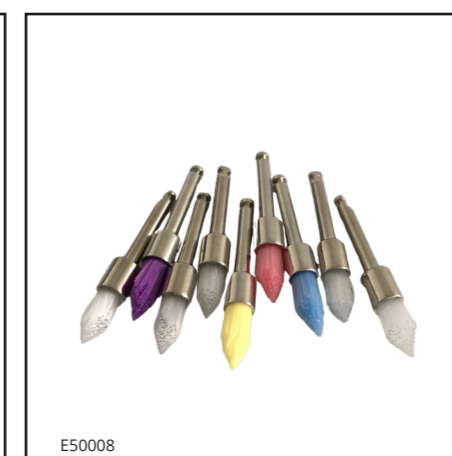

Prophy Brush

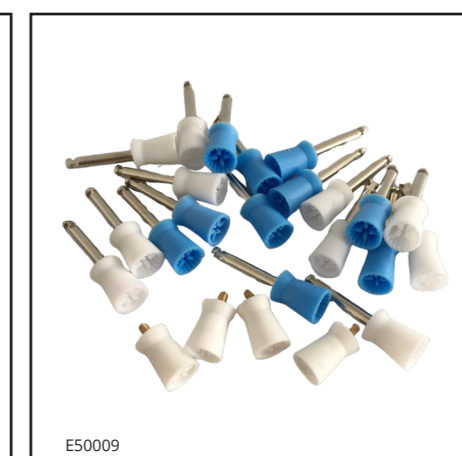

Prophy Cup



Air-Water Syringe tips



Mixing Tip



Dental Stone



E50013

Silicone Impression Materials



E50014

Mixing Dispenser Gun



E50015

Hemostatic Sponge Gelatin

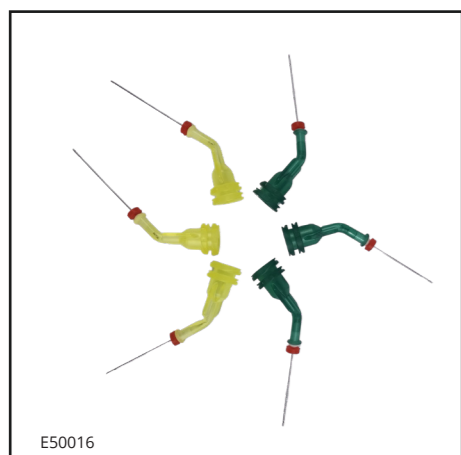

E50016

Endo Irrigation Needle with Stopper, Angle Type



E50017

Endo Irrigation Needle



E50018

Plastic Dental Impression Tray



E50019

Plastic-Steel Dental Impression Tray



E50020

Stainless Steel Dental Impression Tray



SHANGHAI EVEN MEDICAL INSTRUMENTS CO.,LTD

GROW YOUR COMPANY WITH US



ADDRESS

Room 201, #2 Lingguang Building, 2511 West Huancheng Rd, Fengxian District, Shanghai, China.



CONTACT

info@shevenmed.com
https://shevenmed.com

